

# INSTRUCTION MANUAL FOR

---

## VEND-MASTER & VEND-MASTER VALIDATOR



# Table of Contents

Subject	Page
<b>IMPORTANT WALL INSTALLATION NOTICE</b>	2
<b>BLANK PAGE FOR NOTES</b>	3
Important Notices	4
Vendor Information	5
Operation Guide	6
Installing the Changer	7
Electrical Power	8
Circuit Breaker and Transformer	8
Product Loading	8-10
MDB Controller [Main Board]	11
MDB Controller Operation	12
Programming	13-14
Changing Augers	15
Removing the Cash Box	16
Removing Vend Trays	16
Replacing Motors	16
Controller and Key Pad Assembly [fig X]	17
Removing Controller and Key Pad	18
Removing Delivery Door	18
Removing the Power Box	18
Light Bulb Replacement	18
Suggested Product Placement	19
Installation of Door Lock-Bar	20
Installation of Door Lock	21
Trouble-shooting Guide	22-23
Electrical Diagram	24
High Voltage Electrical Diagram	25

# VEND-MASTER WALL INSTALLATION INSTRUCTIONS

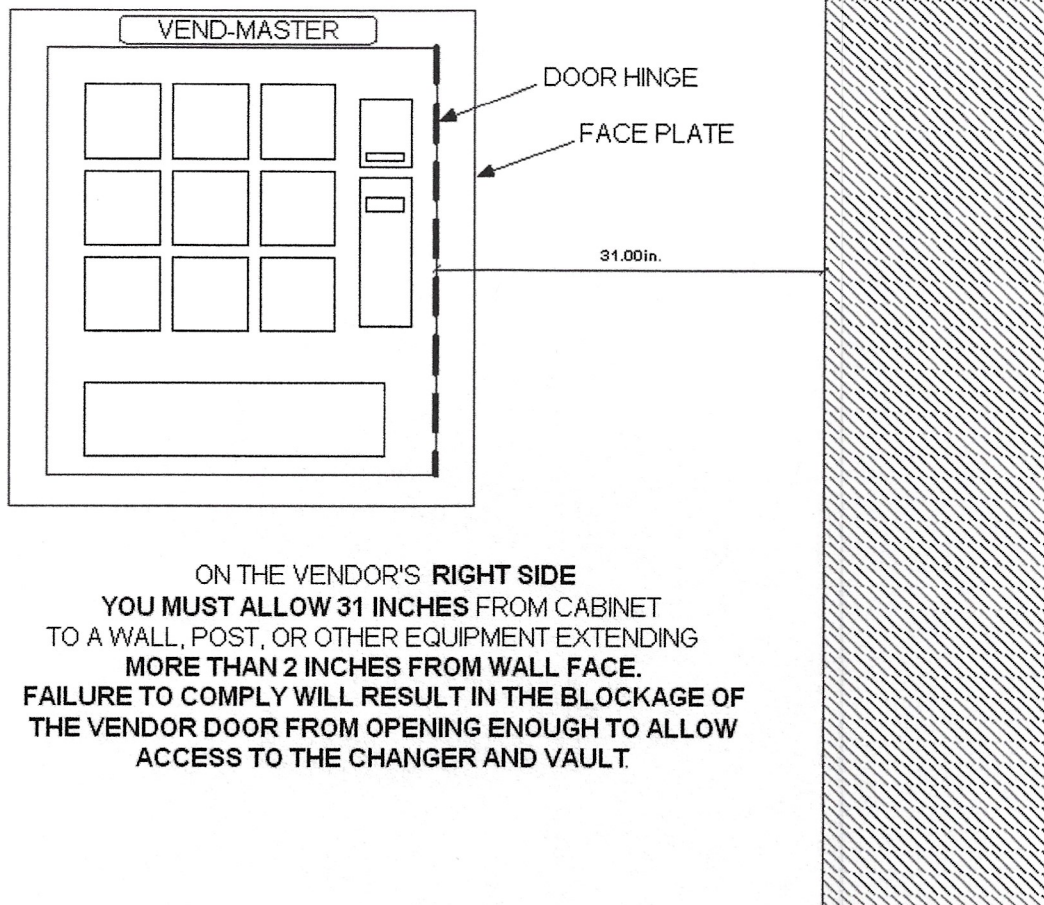

**ON THE VENDOR'S RIGHT SIDE  
YOU MUST ALLOW 31 INCHES FROM CABINET  
TO A WALL, POST, OR OTHER EQUIPMENT EXTENDING  
MORE THAN 2 INCHES FROM WALL FACE.  
FAILURE TO COMPLY WILL RESULT IN THE BLOCKAGE OF  
THE VENDOR DOOR FROM OPENING ENOUGH TO ALLOW  
ACCESS TO THE CHANGER AND VAULT.**

**NOTES**

# IMPORTANT NOTICES

---

After the unit is installed it must be securely fastened to wall with enclosed mounting brackets.

Disconnect power before connecting or disconnecting the changer, dollar bill acceptor, electronic controller or any other electrical device.

Vendor must be protected from lightning, electrical surge protection must be provided at the wall outlet.

Inspect the unit immediately upon receipt for freight damage. Claims must be made to the freight carrier.

Do not touch light bulb with bare skin, it may be hot and premature failure will occur.

Packing envelope contains price tabs, spiral end pushers, and changer and validator manuals.

---

## FRONT AND REAR LOADING VENDOR

This vendor is designed to allow you access to the product and cash from the front or back, however you must open the front to load change into the changer or to perform repairs to the changer or bill acceptor.

### **Loading Product:**

Loading your products can be done from either side. The front door of the vendor can remain shut and locked when loading from the rear.

**Loading from front:** Lift tray and pull toward you until it stops and the tilt the tray down slowly. [reverse order to return shelf]

**Loading from rear:** [same as above] plus after loading push shelf in forward until it stops.

Note: There are wiring harnesses connected to each tray. It may be necessary to move each harness so binding will not occur during loading of product.

*If you load your stock from the front* the harnesses should be hanging in the open space behind the changer.[left side looking from the back]

*If you load your stock from the rear* the harnesses should be hanging over the back of the trays between the trays and the rear panel coming from the bottom of the cabinet.

### **Cash Access:**

This can be performed from the front or rear of the vendor.

**Front:** Unlock the lock bar from the rear of the vendor, Open the front door, disengage the lock bar and open door fully, slide the changer assembly out until it stops, remove the money, push the slide lock button and slide assembly back into the vendor, close the door and attach the locking bar to the door, close door completely, lock the bar at the rear of the vendor.

**Rear:** Pull rear vendor panel off, reach in and remove the bill stacker, remove the money and reinstall stacker, remove the coin tray stop [push stop forward then pull up], slide coin box back and remove coins, reinstall coin box and push towards front of vendor, reinstall coin box stop into slot, reinstall rear panel.

## FRONT LOCK VEND-MASTER [optional]

The front lock option is equipped with 2 Medico High-Security T-Handle locks. Record your key numbers and keep in a safe place. These keys **CANNOT** be duplicated. New keys can be made if you provide the key number. These locks feature a stainless steel threaded lock shaft. Keep the lock shaft clean and lubricated with anti-seize.

The locks are very precise and have been thoroughly checked before shipping. If the T-Handle lock becomes hard to screw in, **DO NOT FORCE!** Unthread lock and check threads. It may become necessary to clean the shaft and/or nut threads. Replace threaded nut before damage occurs, or if threads are visibly damaged.

## I. **Operation Guide**

### **CONTROL SETUP AND OPERATION**

Press mode switch once to enter service mode. Then press appropriate button on door front selection pad.

### **COIN DISPENSE**

Press 1 – (Display will show “Coin”)

Press 1 to dispense lowest value coin

Press 2 to dispense next value coin

Press 3 to dispense next value coin

Press 4 to dispense next value coin

Press 6 to EXIT FUNCTION

### **PRICE SETTING**

Press 3 – (Display will show “PRC”)

Press 1 to set single selection

Press Selection – Press 8 to increase price

Press 9 to decrease price

Press 2 to set row prices.

Press Row letter, adjust price by pressing 8 or 9

Press 6 to EXIT FUNCTION

### **VEND OPTIONS**

Press 5 – (Display will show “opt”)

Press 0 for Forced Vend On (Standard Setting)

Press 1 for Forced Vend Off

Press 2 for Bill Escrow On

Press 3 for Bill Escrow Off (Standard Setting)

Press 4 for Multi-Vend On

Press 5 for Multi-Vend Off (Standard Setting)

Press 6 to EXIT FUNCTION

### **EXIT SERVICE MODE**

Press mode button or wait 30 seconds

A detailed outline of all functions is located on pages 10 and 11.

## II. INSTALLING THE CHANGER [IF NOT EQUIPPED]

CAUTION: DO NOT PLUG IN OR UNPLUG THE CHANGER OR BILL ACCEPTOR WHILE THE POWER IS ON!

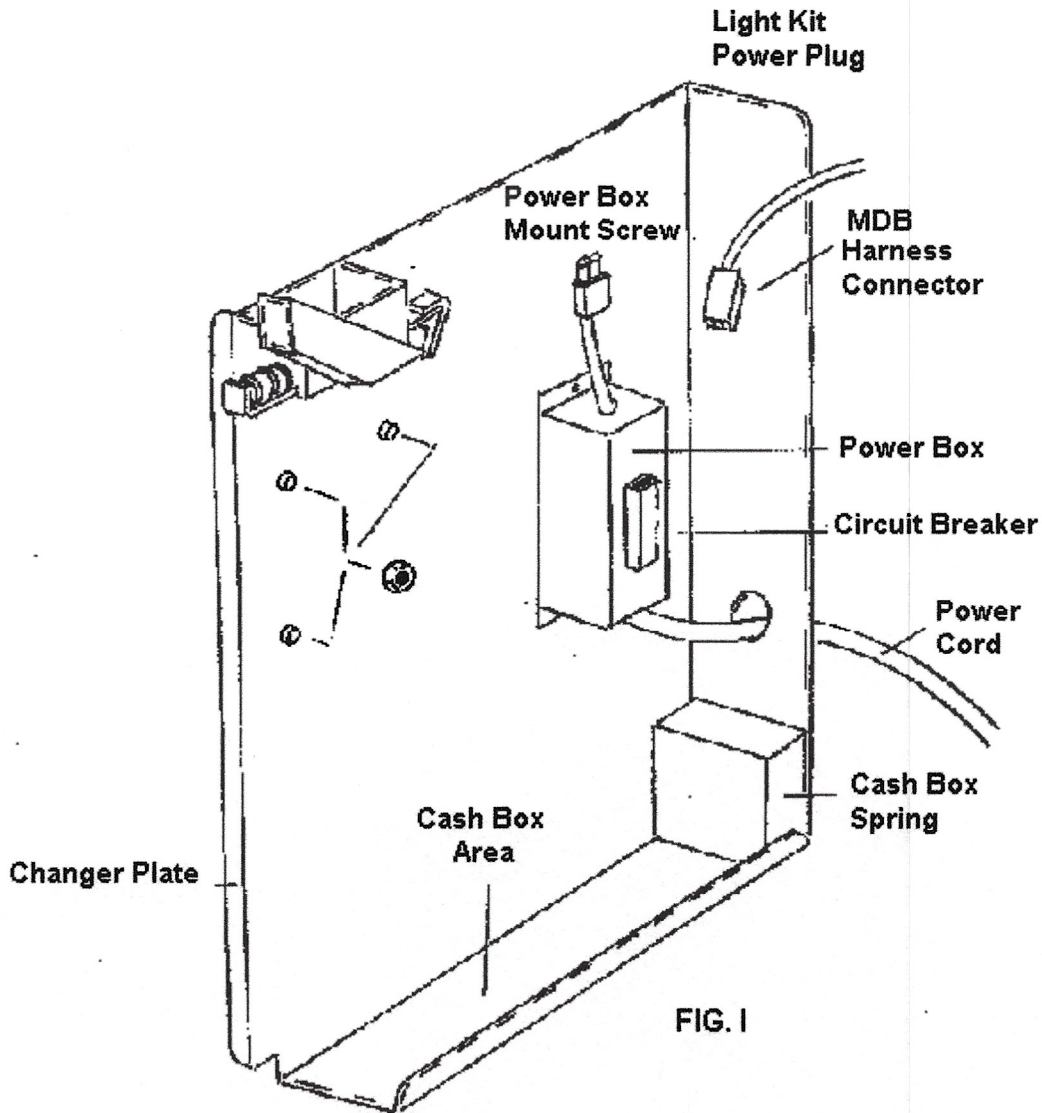

To install the changer, slide the changer plate out until it stops (See FIG. 1). Make sure the retainer nuts are mounted on the two changer mounting studs with enough gaps for the changer back. Now place the changer on the mounting studs. Complete the installation by plugging the connector from the changer into the MDB harness connector (See FIG. 1).



### III. ELECTRICAL POWER

Plug your Vend-Master into an approved 115 VAC outlet which has a safety ground. Surge protection must be provided at the wall outlet.

### IV. CIRCUIT BREAKER AND TRANSFORMER

Your Vend-Master converts 115 VAC power [230 VAC for export machines] from the wall socket to its operation voltage of 24 VAC with a step down transformer. It is located in the power box [See FIG. 1 on page 4]

### V. PRODUCT LOADING NOTICE

Some "Soft" packaging, like Armor-All, Rain-X Packet, Wet Towels, Etc... needs to be folded for proper vending.

See diagram below for example.

**CONTINUE TO SECTIONS VI – XIV FOR MORE IMPORTANT INFORMATION !**

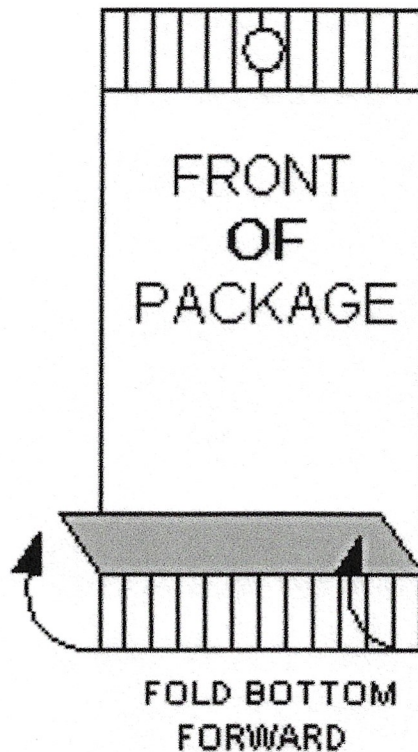

## VI. LOADING THE PRODUCT

NOTICE: To get a good vend, it is important that each product is loaded properly. The bottom of the product must rest on the vend tray and not on the auger (See FIG. III).

NOTICE: Never force the product between the spirals of the auger. If the product is too tight, use the next larger auger.

NOTICE: Be sure the end of the auger extends to or slightly beyond the end of the vend tray. **End of auger should be in 3 o'clock position.** The Vend-Master is already pre-set from the factory to vend products that come in the starter pack. If you are vending items other than what is in the starter pack, you will have to adjust the spiral position to find what position gives the most consistent vend. To do this, simply pull the back of the spiral hub out and turn the spiral to desired position, and push the spiral hub back into the motor.

To load the product, unlatch the tray (Section VI) and pull it forward. When the rear stop is engaged, lower the front of the tray. You are now ready to load the product. Never load more than one tray at a time.

After the tray is loaded, lift its front and push it home. Be sure to reset the tray latch.

The top tray in the Vend-Master has been lowered to provide more space for taller products.



FIG. III

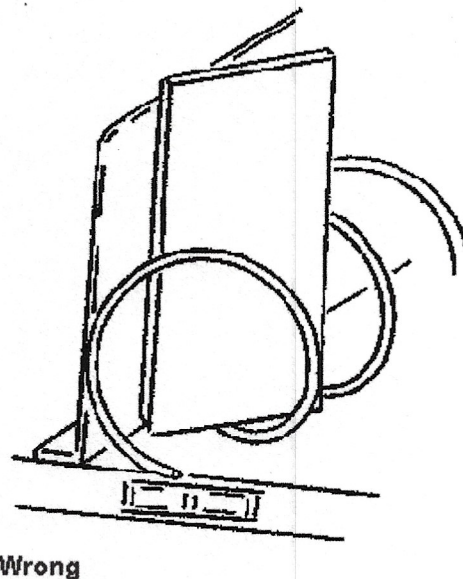

## VII. PRODUCT PUSHERS

To get a good vend, the end of the vend auger must extend to or slightly past the edge of the tray. This insures that the product will be pushed completely off the tray.

To increase the length of the auger, a plastic product pusher can be snapped on the end as shown in FIG. IV. A supply of product pushers is in the plastic envelope.

FIG. IV

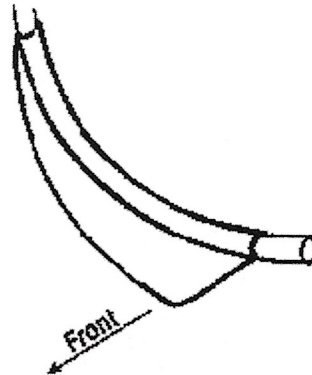

## VIII. PRICE TABS

In the plastic envelope you will find a card of price tabs. Peel off the appropriate price, place on shelf as shown in FIG. V.

FIG. V

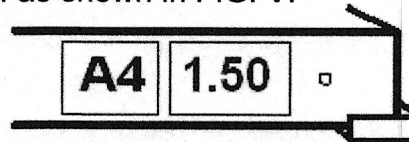

## XIV. PRODUCT SPACER

Each Vend-Master is supplied with 2 product spacers. These are used to position thin products to the left and hold them upright.

The product spacers are mounted as shown in FIG. VI. Make sure it does not interfere with the rotation of the auger hub.

FIG. VI

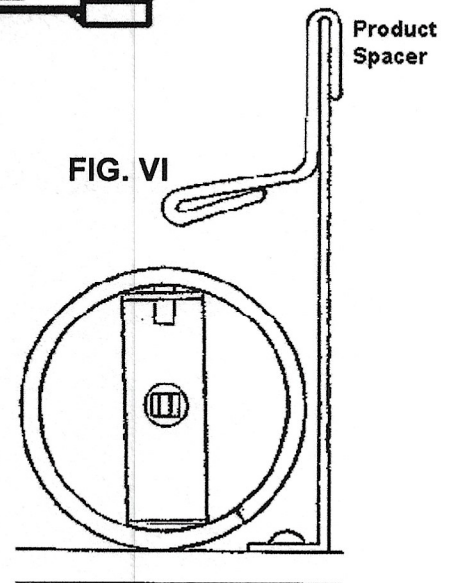

## X. MDB CONTROLLER DESCRIPTION

The MDB Controller is designed for years of service and features the industries longest warranty.

The board contains the LED display and control system in one compact package.

See FIG. VII for mode switch and harness connector locations.

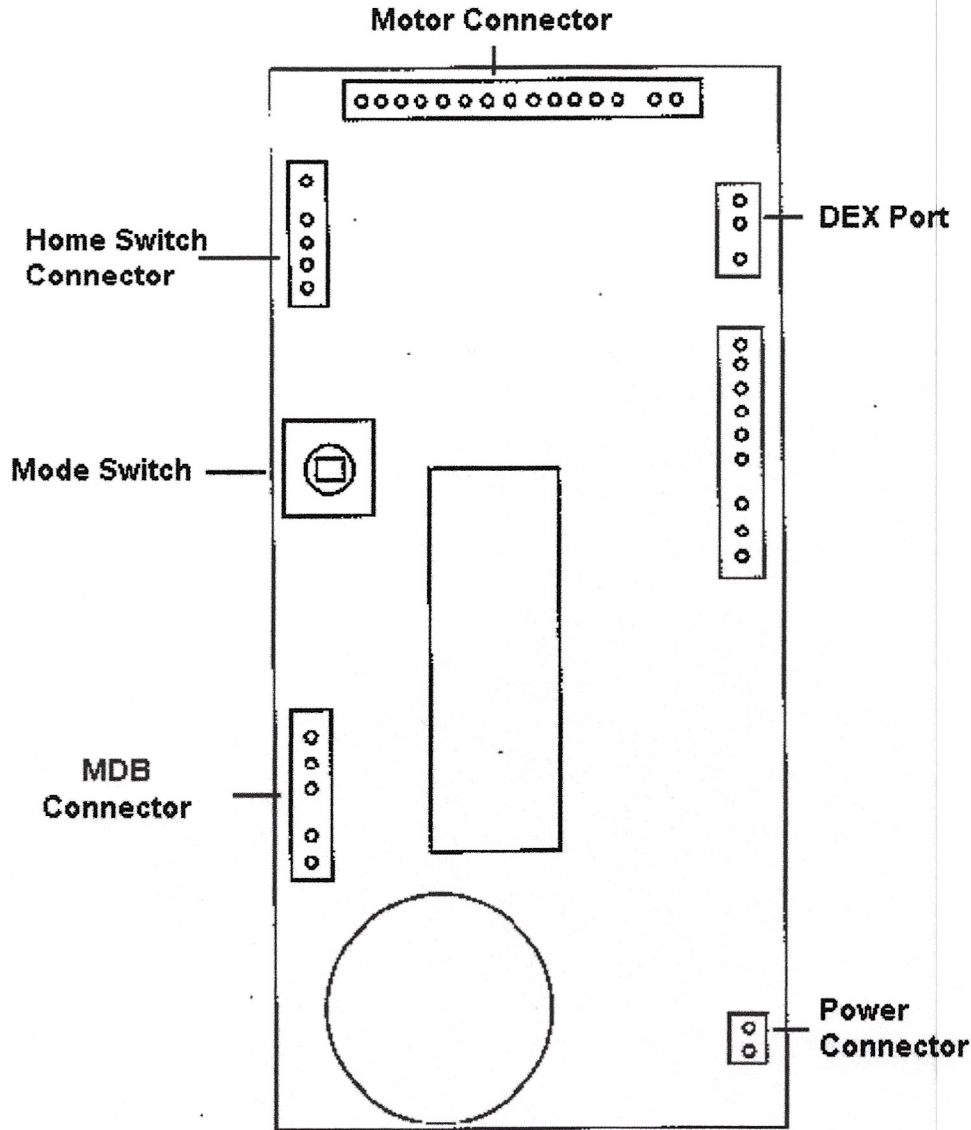

FIG. VII

## **XI. MDB CONTROLLER OPERATION**

The electronic controller functions as the brain of your Vend-Master and has the following operating characteristics:

1. The changer will not accept coins when
  - a. the top vend price has been reached,
  - b. the changer has no power or,
  - c. the machine is in vend cycle.
2. The "EXACT CHANGE" light will be lit when there is insufficient change in the coin tubes. During this time, change will not be given. The MDB electronics does not check coin levels in the tubes. It counts coins accepted and coins paid out.
3. The LED credit display will show the total amount of money deposited. If the selection price is greater than the deposits, the display will flash "CHECK PRICE".
4. The bill acceptor will not take bills if
  - a. the top vend price has been reached,
  - b. there are insufficient coins in the change tubes,
  - c. the unit has no power,
  - d. the machine is in vend cycle or,
  - e. the bill stacker is full.
5. Selection is made by first pressing the letter (A, B, C etc.) and then the number of the desired item. If no credit has been established, the item's price will be flashed on the display.
6. If a vend motor fails to make a complete turn, "MAKE ALTERNATE SELECTION" will flash on the display.
7. The electronic controller can be programmed to do the following
  - a. FORCED VEND on or off. This feature insures the vendor will not be used as a bill changer. (On is Standard Setting)
  - b. BILL ESCROW on or off. This feature returns the last bill inserted instead of change if a selection is not made. (Off is Standard Setting)
  - c. MULTI-VEND on or off. This feature allows a customer to buy multiple items up to the amount of the deposit. Change is returned when the reject button is pressed. (Off is Standard Setting)
8. This MDB controller features a DEX port for remote retrieval of data.

## **XII. MDB CONTROLLER PROGRAMMING**

To dispense coins from the changer, access accounting registers, set vend prices, test motors, and select vend options, you must enter the SERVICE MODE.

Press the MODE button on the controller to enter SERVICE MODE. "SET" will be displayed.

Press 1 to enter COIN DISPENSING function.

Press 2 to enter ACCOUTNING function.

Press 3 to enter PRICE SETTING function.

Press 4 to enter MOTOR TEST function.

Press 5 to enter VEND OPTIONS function.

To return to SALES MODE, press the MODE button or wait 30 seconds with no activity.

### **A. COIN DISPENSING FUNCTION**

Press 1 to enter. "Coin" will be displayed.

Press 1 again to dispense lowest coin value. The coin value will be displayed.

Press 2 to dispense next coin. The coin value will be displayed.

Press 3 to dispense next coin. The coin value will be displayed.

Press 4 to dispense next coin. The coin value will be displayed.

Press 6 to EXIT FUNCTION.

### **B. ACCOUNTING FUNCTION**

Press 2 to enter. "ACCT" will be displayed.

Press 1 to read total vend counter. "SALE" will display 1 second, then the total non-resettable vend count will appear.

Press 2 to read total cash counter. "CASH" will display, then the total non-resettable cash count will appear.

Press 3 to read resettable vend counter. "r SLE" will be displayed, then the total vends since last reset will appear.

Press 4 to read resettable cash counter. "r CSH" will be displayed, then the total cash taken since last reset will appear.

Press 5 to clear resettable counters.

Press 6 to EXIT FUNCTION.

### C. PRICE SETTING FUNCTION

Press 3 to enter. "PrC" will be displayed.

Press 1 to set a single selection price. "ONE" will be displayed until a valid selection is pressed. Then the selection's price will appear. Press 8 to increase the price and 9 to decrease it.

Repeat this process for each selection to be priced.

Press 2 to set a total row of prices. "ro" will be displayed until a row letter is pushed (A, B, C etc.). Then the current price will be displayed. Press 8 or 9 to adjust the price.

Press 6 to EXIT FUNCTION.

### D. MOTOR TEST FUNCTION

Press 4 to enter. "TEST" will be displayed.

Press 1 to read valid motor count.

Press 2 to vend a single selection. "ONE" will be displayed until a selection is pressed. Repeat this process for each selection to be tested.

Press 3 to test a row of motors. "ro" will display until a row letter is pushed (A, B, etc.).

Press 4 to test all motors in the machine.

Press 6 to EXIT FUNCTION.

### E. VEND OPTIONS FUNCTION

Press 5 to enter. "oPt" will be displayed.

Press 0 for FORCED VEND on. "F-on" will be displayed.

Press 1 for FORCED VEND off. "F-oF" will be displayed.

Press 2 for BILL ESCROW on. "E-on" will be displayed.

Press 3 for BILL ESCROW off. "E-oF" will be displayed.

Press 4 for MULTI-VEND on. "U-on" will be displayed.

Press 5 for MULTI-VEND off. "U-oF" will be displayed.

Press 6 to EXIT FUNCTION.

### F. TUBE LOAD FUNCTION

Coins can be added to the change tubes by passing the vend cycle with this function.

**ALL COINS MUST BE LOADED THROUGH THE ACCEPTOR.**

Press 7 to enter. "t-Ld" will be displayed.

Load lowest value coins first. The coin count and value will be displayed.

Load the next lowest coins. The coin count and value will be displayed. Repeat process until all coins are loaded.

Press 6 to EXIT FUNCTION.

### XIII. CHANGING AUGERS

To remove only the auger, lift the auger front up until it pops off the bottom flange of the auger hub, then lift it out of the retaining hole (See FIG. VIII). To replace the auger, reverse the process and push the bottom on with a flat-bladed screwdriver (See FIG. IX). To remove the auger and hub, squeeze the motor output shaft locking lips together with needle nose pliers while pulling the hub towards you.

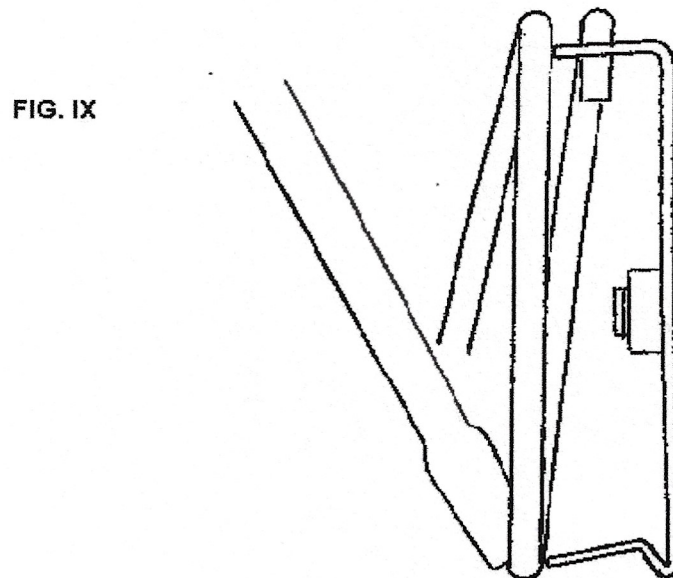
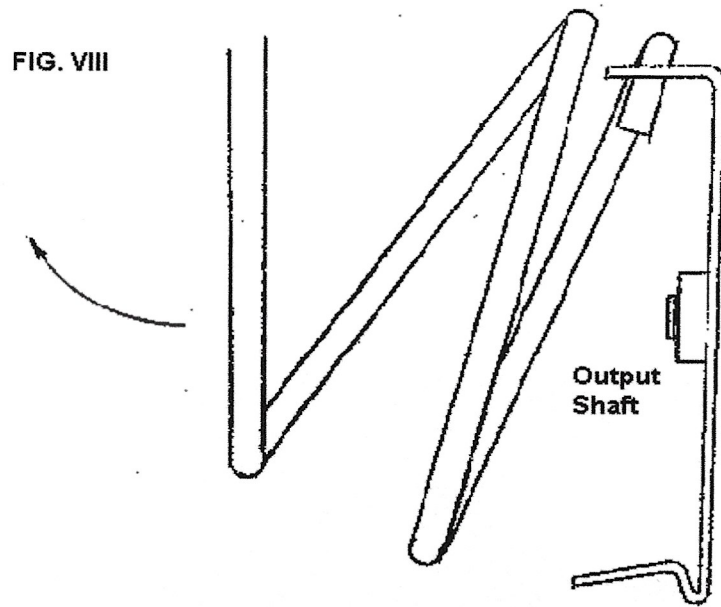



#### **XIV. REMOVING THE CASH BOX**

To remove the cash box, changer, or validator, you must first open the service door. Pull the cash box towards you and all the way out. Return the cash box in reverse, notice the left side of the cash box will travel between the changer and the changer plate.

#### **XV. REMOVING VEND TRAYS**

To remove vend tray, lift front of tray, pull the tray forward till the rear tray stop is engaged. Now lift the front of the tray up till the rear tray stop is clear and pull the tray out. Disconnect the tray harness, and you have completed the removal. To reinstall tray, reverse this process. CAUTION: Be careful not to damage the motors.

#### **XVI. REPLACING MOTORS**

If a vend motor draws 300MA current or fails to complete rotation in 8 seconds, the electronics will signal "MAKE ALTERNATE SELECTION".

To remove a motor, first remove the vend tray. Then undo the harness and remove the two No. 8 screws securing the motor.

NOTE: Black signal wire goes on the top .187 wide terminal.

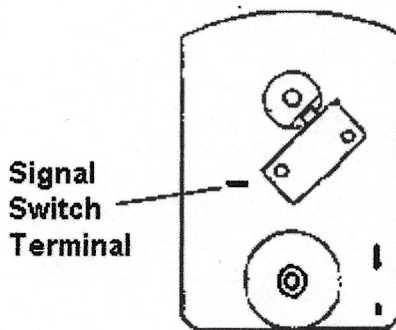

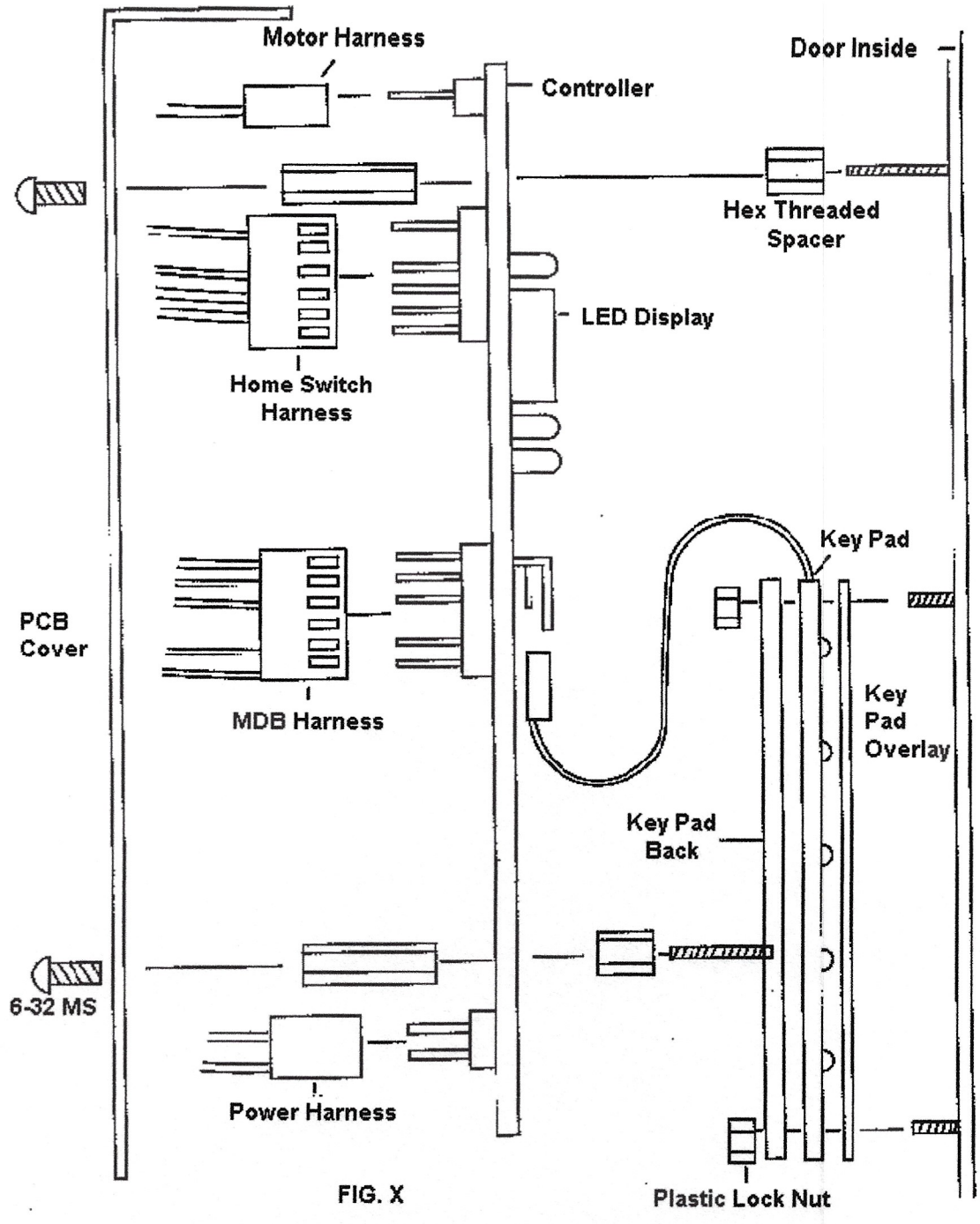

## **XVII. REMOVING THE CONTROLLER AND KEYPAD**

### **TURN OFF POWER!!**

CAUTION: Use extreme care while handling the electronic controller.

To remove the controller and keypad, first remove the PCB cover, then the harnesses plugged to it. Remember the orientation.

Then remove the four hex nuts holding the controller (See FIG. X). Gently pull it off the studs and disconnect the keypad harness, which is connected to the backside of the controller.

To remove the keypad back, the keypad and keypad overlay, undo the four plastic nuts holding it with a nut driver.

## **XVIII. INSTALLING REPLACEMENT CONTROLLER**

When replacing a Defective or Damaged Controller, Install the controller in reverse order as above in XVII.

**CRITICAL STEP:** After installation is complete, apply power to the vendor, Press the Yellow **MODE** button 1 time. Press the #4 button on the keypad 2 times. Each spiral will turn one at a time. When it is finished you will need to enter your prices for each item. (How? See page #14, "C" PRICE SETTING FUNCTION)

## **XIV. REMOVING THE DELIVERY DOOR**

First open the service door. Grasp the left hand side of the steel rod the delivery door pivots on with pliers. Tap the pliers so the rod moves to the left. This will pull the rod out of the retainer located in the right hand side of the door. Now the rod and door are free. Reverse the process to reinstall.

## **XX. REMOVING THE POWER BOX**

To remove the power box, you must first remove the changer plate. This is done by removing the two screws, which hold the changer plate latch. They are located on the left hand side of the front frame middle upright.

The changer plate can now be pulled completely out of the machine as far as the power cord will allow.

The two screws, which hold the power box to the changer plate, can now be removed. They are located on the backside of the changer plate.

## **XXI. LIGHT BULB REPLACEMENT**

CAUTION: BULB MAY BE HOT!

This is a special 24v AC bulb, DO NOT replace with an Automotive bulb, Automotive bulbs are 12v DC and will burn out quickly.

To replace the bulb, first remove the light cover. Then remove the bulb. Do not touch the **new** bulb with bare skin, it will cause premature failure.

## **XXII. SUGGESTED PRODUCT PLACEMENT**

The Vend-Master is designed to vend car care products.

The top shelf [A] is designed for Armor-All Protectant Packets and/or like size products.

The second shelf [B] is designed for Blue Towels, Window Cleaner Packets, etc.

The third shelf [C] has narrow spirals for Air Freshener Cards, Armor-All 4oz. cans, Tire Foam 4oz., and Armor-All plastic spray bottles. A "**CAN TIPPER**" is provided to be placed on the product vend floor to tip the 4oz. cans over so they do not land upright and block access door from opening. Place the **CAN TIPPER** on the floor under shelf C between the spirals where products will fall. Use the self-sticking adhesive provided on the **CAN TIPPER** to secure it firmly to the floor.

The **CAN TIPPER** can be cut in two with a hack-saw to provide more coverage if needed.

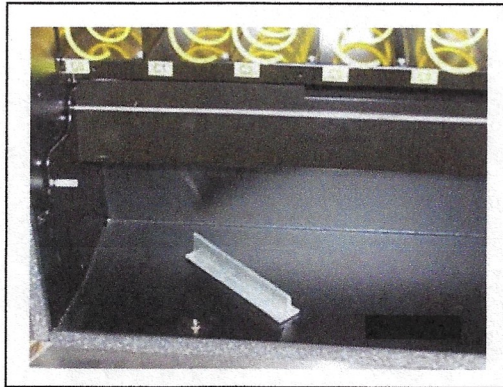

**Please refer back to pages 6 & 7 for proper loading of product.**

### XXIII.        INSTALLATION OF DOOR LOCK-BAR

- A. Find plastic bag with plastic washer, spring, and screw.  
[parts shown in FIG. A]
- B. Inside of cabinet, find bolt hole on left side center of cabinet. [FIG. B]
- C. Slide back of lock-bar through slot in rear of vendor, the slot is located on the left hand side between the first and second shelf. Make sure that the lip on front of lock-bar is facing to the outside of the vendor. [FIG. C]
- D. Install screw and spring assembly as shown in FIG. D.
- E. Once the lock bar is installed connect the lock-bar to the door and close door. Lock door as shown on the following page: "INSTALLATION OF DOOR LOCK".

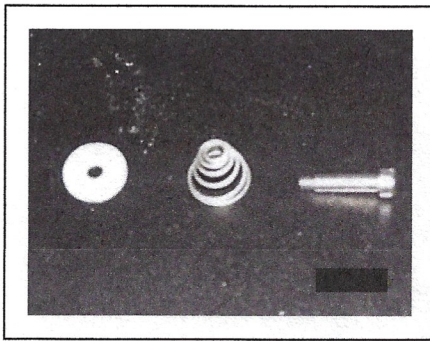

FIG. A

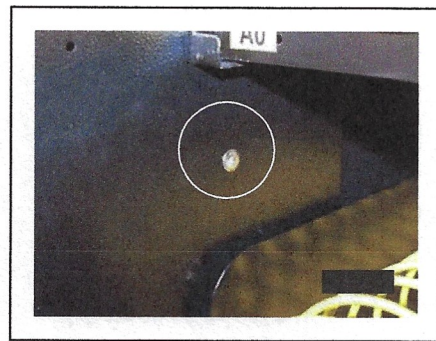

FIG. B



FIG. C [VIEWED FROM ABOVE]

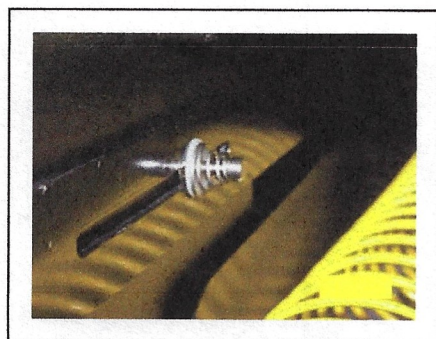

FIG. D

#### XXIV. INSTALLATION OF DOOR LOCK

A: FIND BENT METAL TAB WITH HOLE. [FIG. 1]

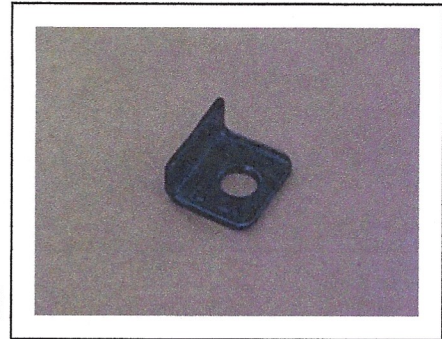

FIG.1

B: WITH DOOR LOCK BAR IN PLACE AND DOOR CLOSED, SLIDE METAL LOCKING TAB THROUGH THE SLOTS IN THE LOCKING BAR AND THE LOCKING SUPPORT ON THE CABINET. [FIG. 2A & B]

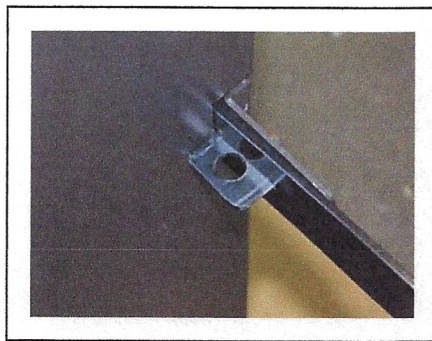

FIG. 2A

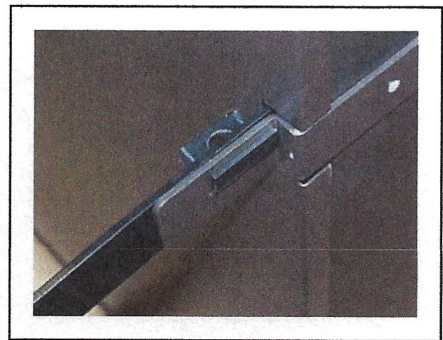

FIG. 2B

C: PLACE PAD LOCK AS SHOWN [FIG. 3], IF YOU REMOVE THE REAR PANEL OFTEN- THEN PLACE THE TAB THRU THE OTHER SIDE, THE LOCK WILL THEN BE OUT OF THE WAY OF THE PAN

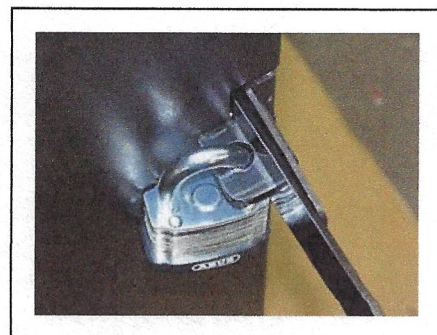

FIG. 3

---

## **Vend-Master Trouble-shooting Guide**

### **My vendor is not accepting coins.**

1. Is there power to the vendor, (is it plugged in) and is it turned on?
2. Is the RED LED on the front of the coin changer lit?
3. Is the RED LED on the coin changer flashing an error code or is it constantly lit?
4. If the changer is flashing a code, what error code is the changer alerting you to?  
Codes are listed on coin changer directly above the RED LED.

### **My vendor will not accept currency.**

1. Is there power to the vendor.
2. (is it plugged in) and is it turned on? Is the vendor equipped with a bill validator? Is the RED LED on the back of the validator lit? If the validator is flashing a code, what error code is the validator alerting you to? Codes are listed on bill stacker.
3. Is the power cable securely plugged in the side of the validator? (unplug and re-insert)
4. Is there enough money in the changer to give change of a \$5.00 bill for your lowest priced item in the vendor?

### **Products are falling against the window and/or hanging up and not dropping properly to the delivery area.**

1. Is the product a soft packet (such as: Armor All Sponge Pak, Wet Towel, Window Wipe)? If so, make sure the bottom of the flap of the packet is folded forward and that the product is not setting on the spiral but is setting on the bottom of the shelf. See owner's manual for details.
2. If problem still persists try using the white "product pushers" that are included in the accessory pack that come with the vendor. The pushers install approximately ¼" from the end of the spiral. See owner's manual for details.

**Product motor will not vend item.**

1. Is the product priced correctly in the vendor control board (ex. The price decal states \$1.00, is the price for that item programmed at \$1.00 in the control board.) See owner's manual for details.
2. Perform a motor test using control board service mode. See owner's manual for details.
3. Check all terminal connections at back of vend motor.
4. Switch problem motor with motor that is known to work properly and see if problem "travels" with problem motor. If not, check all wiring harness connections between vend-motors and control board.

**My vendor is vending items for FREE.**

1. The item is priced at \$0.00 in the control board. Set product pricing to correct price and re-test. See owner's manual for details.

**My vendor buttons are not working. Why are they hard to push?**

1. Remove touch pad and test touch pad while holding in hand. Does it work?
2. If touch pad works when removed from vendor, remove clear plastic "ice cube" push buttons from door (if equipped). Re-install touch pad and all hardware without buttons.

**My validator is not accepting currency at the correct amount.**

1. Did you attempt to reprogram unit by using dip-switches on side of validator? If so, re-set all switches to "Off" position and reprogram unit using Mars Program Coupon found in the back of the owners manual.

**The bulbs in the vendor door have burned out repeatedly.**

1. Make sure vendor is equipped with voltage step-down resistor in wiring harness that runs from the vendor control board to the light assy's at the top of the door. The resistor should be in-line with the wiring harness. If not equipped, then resistor must be installed to cure problem.



# APPENDIX I

## ELECTRICAL DIAGRAM

### VEND-MASTER

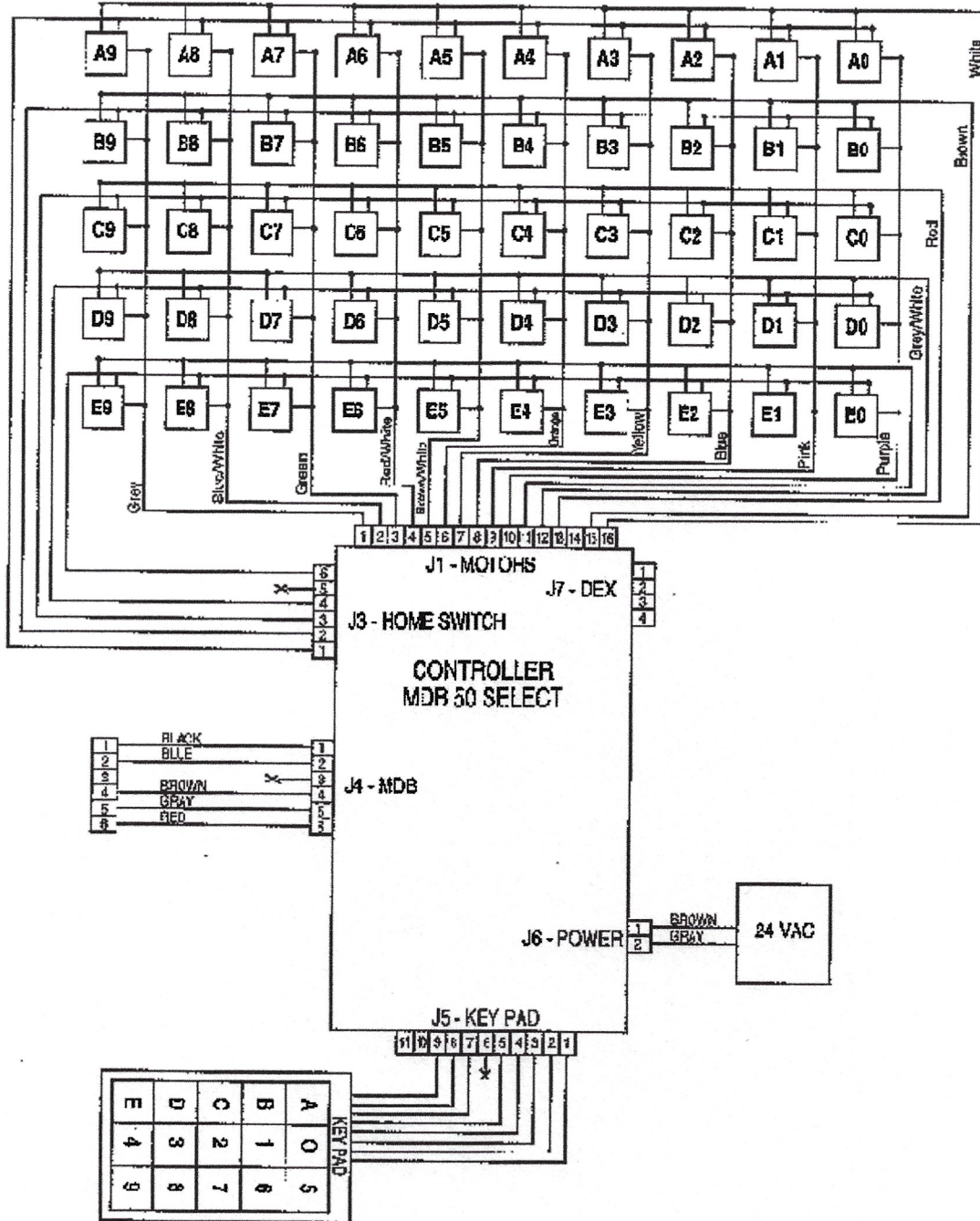

# APPENDIX II HIGH VOLTAGE ELECTRICAL DIAGRAM VEND-MASTER

